

MORE POWER – LESS SPACE™



HIGH RATE SERIES

HR3500

- **Exclusive IPF® Technology optimizes power capacity, cell consistency, and long-term reliability**
- Advanced AGM technology for superior high rate, short term power
- Reinforced case resists bulging and meets safety requirements
- Case & cover heat sealed and 100% tested to prevent leaks
- Epoxy-sealed posts eliminate leaks
- Puncture resistant micro-porous glass mat separators extend life
- Flame arresting, low pressure, self-sealing valves are 100% factory tested
- Computer-aided design, manufacturing control processes, and standards to ensure quality products
- All batteries meet or exceed IEEE recommended practices
- Battery design and construction meet UL recognition requirements



QUALITY SYSTEM
CERTIFIED
ISO 9001
ISO/TS 16949
ENVIRONMENTAL
SYSTEM CERTIFIED
ISO 14001



SPECIFICATIONS

Nominal Voltage: 12-Volt/370 w.p.c.
@ 15 min. rate to 1.67 v.p.c.

Positive Plate: Pure lead, low-calcium,
high-tin alloy

Negative Plate: Lead calcium alloy

Post Seal: Epoxy-sealed

Terminal: Top access,
1/4" - 20 threaded insert

Container: Flame-retardant, polypropylene -
UL 94 V-0/>28% L.O.I.

Safety Vent: Low positive pressure,
self-sealing w/ flame arrestor

Float Voltage: 2.25 v.p.c. ± 0.01 v.p.c. (Range: 13.44
to 13.56 volts per 6-cell battery)

Design Life: 10 years in float applications
at 77°F (25°C)

Dimensions: 12.01" (305 mm) L
x 6.56" (166 mm) W
x 8.24" (209 mm) H

Weight: 71 lbs. (32.2 kg)

DISCHARGE RATE IN WATTS PER CELL RATINGS @ 77°F (25°C)†

Volts Per Cell (VPC)	1 MIN.	5 MINS.	10 MINS.	15 MINS.	20 MINS.	30 MINS.	40 MINS.	50 MINS.	60 MINS.
1.60	1200	729	489	377	311	231	184	152	131
1.67	1063	686	475	370	305	227	181	150	130
1.70	1015	662	464	364	300	224	180	149	129
1.75	890	608	438	347	291	220	177	147	127
1.80	—	544	405	328	275	210	170	142	123

† Subject to change without notice.

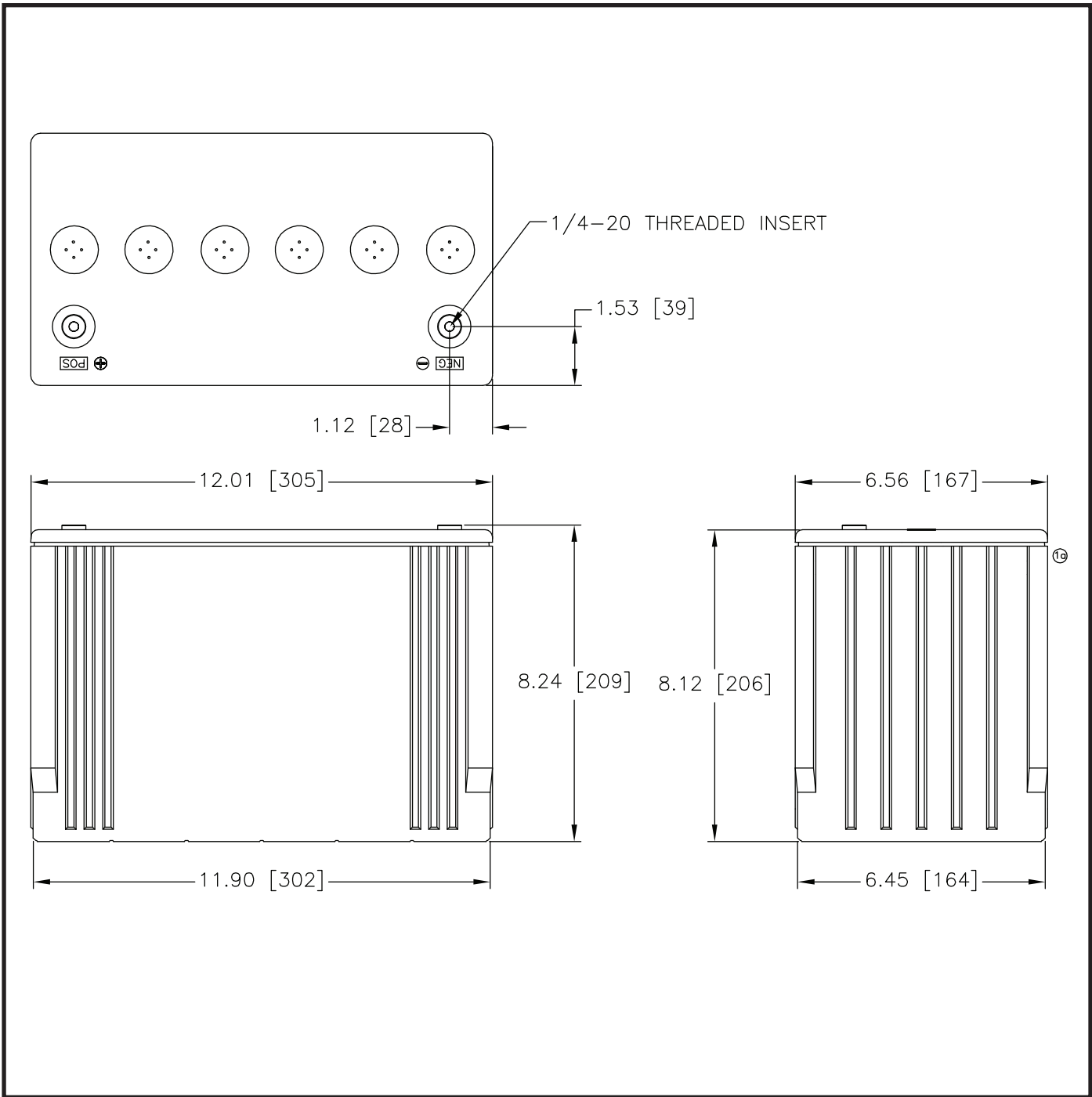

EAST PENN manufacturing co., inc.

Lyon Station, PA 19536-0147 • Phone: 610-682-6361 • Fax: 610-682-4781

Order Department Hotline: 610-682-4231

www.eastpennunigy.com • e-mail: sales@eastpennunigy.com

E.P.M. Form No. 2009 7/13 © 2013 by EPM Printed in U.S.A.

All data subject to change without notice.
No part of this document may be copied or reproduced, electronically
or mechanically, without written permission from the company.