

Powered by



EVX 12650 ▶ 12V 65Ah

EVX 12650 is designed specially for electric vehicles, such as electric golf cart, electric wheelchair, mower, dust collector...etc. It has high cycling life, high efficiency and long service life.



► Specification

Cells Per Unit	6
Voltage Per Unit	12
Capacity	65Ah @ 20hr-rate to 1.75V per cell @25 °C (77°F)
Weight	Approx. 22.2 kg (48.94 lbs)
Maximum Discharge Current	500A(5sec)
Internal Resistance	Approx. 8 mΩ
Operating Temperature Range	Discharge: -15°C~50°C (5°F~122°F) Charge: -15 °C~40°C (5°F~104°F) Storage: -15°C~40°C (5°F~104°F)
Nominal Operating Temperature Range	25°C±3°C(77°F±5°F)
Float Charging Voltage	13.5 to 13.8 VDC/unit Average at 25°C(77°F)
Recommended Maximum Charging Current Limit	19.5A
Equalization and Cycle Service	14.4 to 15.0 VDC/unit Average at 25°C(77°F)
Self Discharge	CSB Batteries can be stored for more than 6 months at 25°C(77°F). Please charge batteries before using. For higher temperatures the time interval will be shorter.
Terminal	B4-L terminal or Recessed Type to accept M6 nut & bolt
Container Material	Polypropylene(UL 94-HB) & Flammability resistance of (UL 94-V0) can be available upon request.



CSB-manufactured VRLA batteries are UL-recognized components under UL1989.

CSB is also certified by ISO 9001 and ISO 14001.

► Dimensions :

Unit: mm (inch)

Overall Height (H)	Container height (h)	Length (L)	Width (W)
174±2 (6.85±0.08)	172.5±2 (6.79±0.08)	349.4±2.5 (13.75±0.1)	166±2 (6.53±0.08)

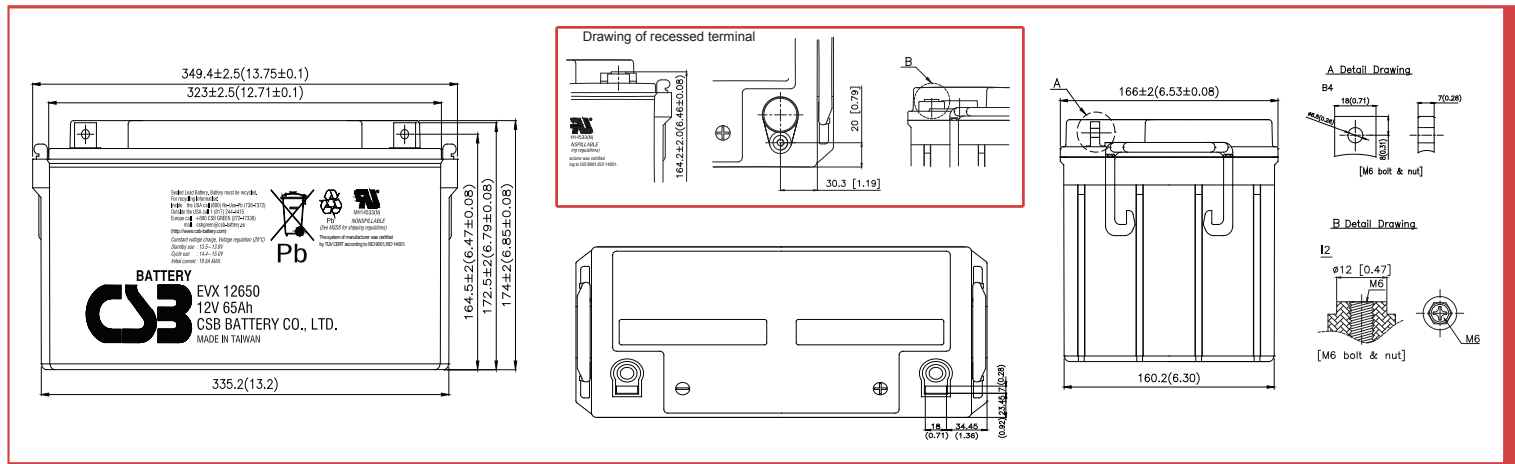

Constant Current Discharge Characteristics Unit:A (25°C, 77°F)

F.V/Time	30MIN	60MIN	90MIN	2HR	3HR	4HR	5HR	8HR	10HR	20HR
1.60V	70.5	41.2	30.0	23.9	17.0	13.4	11.1	7.57	6.31	3.38
1.67V	69.9	41.1	29.8	23.7	16.9	13.3	11.0	7.54	6.28	3.35
1.70V	69.4	40.8	29.6	23.6	16.8	13.2	10.9	7.50	6.24	3.34
1.75V	68.3	40.4	29.4	23.4	16.7	13.1	10.8	7.42	6.16	3.31
1.80V	65.7	39.4	28.8	23.0	16.4	12.9	10.7	7.28	6.04	3.23
1.85V	61.3	37.4	27.5	22.0	15.7	12.4	10.2	6.99	5.78	3.11

Constant Power Discharge Characteristics Unit:W (25°C, 77°F)

F.V/Time	30MIN	60MIN	90MIN	2HR	3HR	4HR	5HR	8HR	10HR	20HR
1.60V	806	484	353	279	199	158	132	90.0	74.7	40.3
1.67V	804	481	351	277	198	157	130	89.6	74.3	40.2
1.70V	795	477	350	276	197	156	129	89.2	74.2	40.0
1.75V	784	475	347	275	196	155	128	88.2	73.2	39.7
1.80V	759	467	342	270	193	151	127	86.9	72.0	38.9
1.85V	714	446	329	259	186	147	122	83.2	68.9	37.8

Ratings presented herein are subject to revision without notice. Please refer to www.csb-battery.com to confirm the latest version.

Trickle (or Float) Service Life

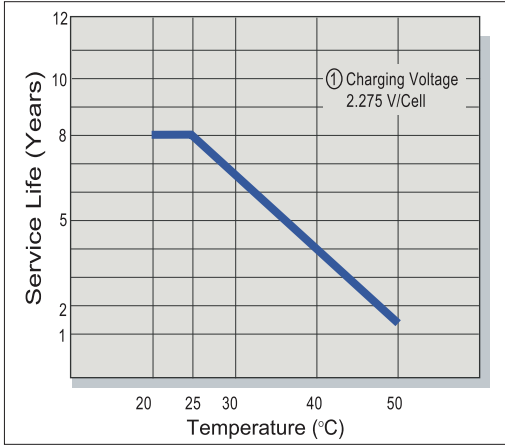

Capacity Retention Characteristic

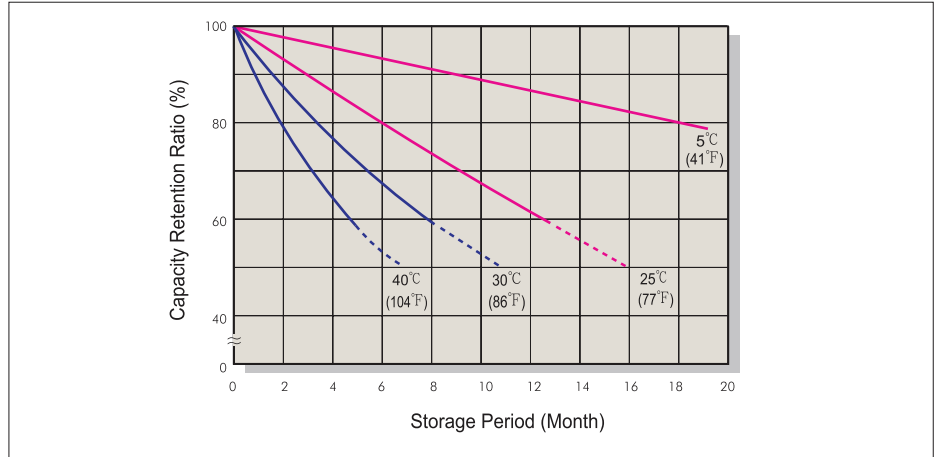

Battery Voltage and Charge Time for Standby Use

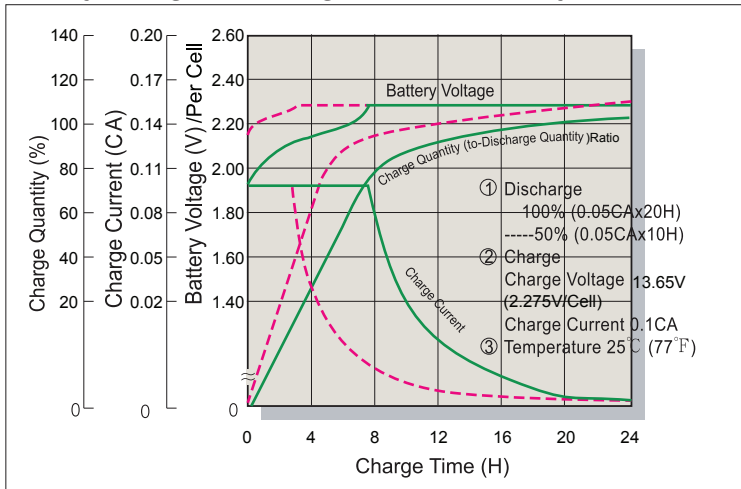

Series Cycle Service Life

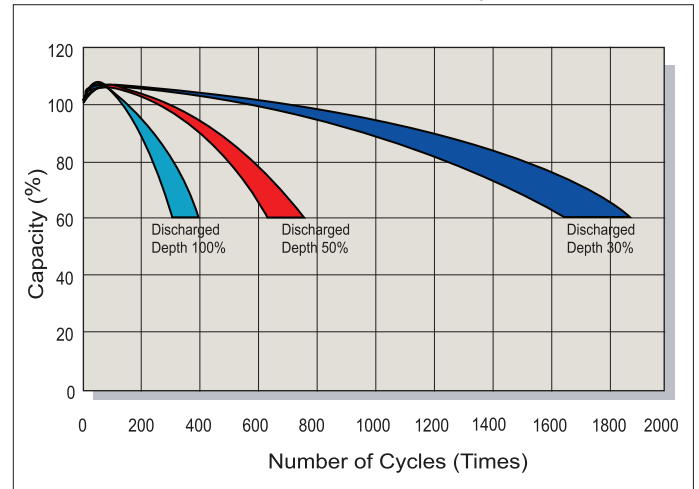

Battery Voltage and Charge Time for Cycle Use

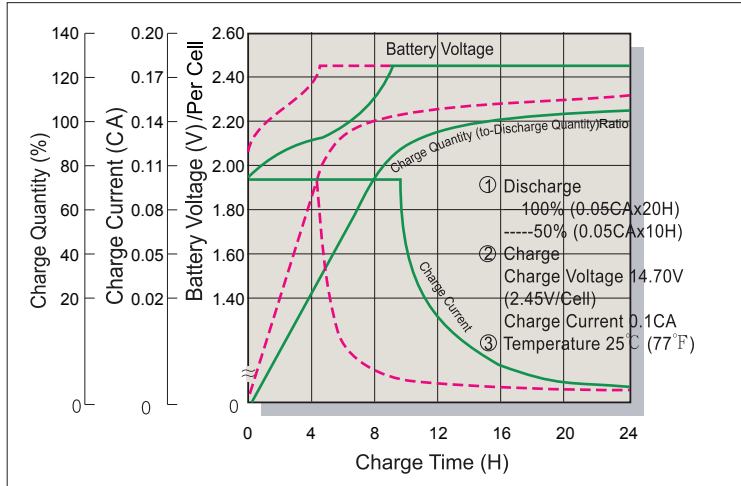

Terminal Voltage (V) and Discharge Time

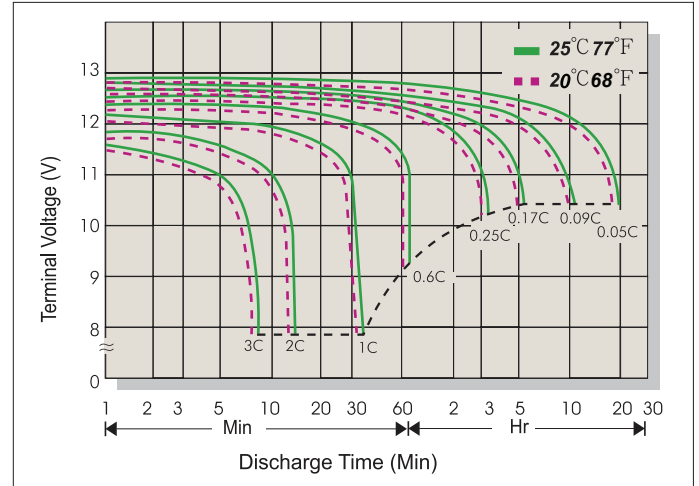

Charging Procedures

Application	Charge Voltage(V/Cell)			Max.Charge Current
	Temperature	Set Point	Allowable Range	
Cycle Use	25°C(77°F)	2.45	2.40~2.50	0.3C
Standby	25°C(77°F)	2.275	2.25~2.30	

Discharge Current VS. Discharge Voltage

Final Discharge Voltage V/Cell	1.75	1.70	1.60	1.30
Discharge Current(A)	0.2C>(A)	0.2C<(A)<0.5C	0.5C<(A)<1.0C	(A)>1.0C

Sales Office URL: WWW.CSB-BATTERY.COM

GLOBAL HQ
CSB BATTERY CO., LTD. (TAIWAN)
 Tel : +886-2-2880-5600
 Fax : +886-2-2888-3300
 mail : service@csb-battery.com.tw

BEIJING OFFICE. (CHINA)
CSB BATTERY TECHNOLOGIES (BEIJING) CO., LTD.
 Tel : +86-10-5820-5336/5338
 Fax : +86-10-58203053
 mail : chinasl@csb-battery.com

AMERICA HQ
CSB BATTERY TECHNOLOGIES INC. (U.S.A)
 Tel : +1-817-244-7777/1-(800)3-CSB-USA(272872)
 Fax : +1-817-244-4445
 mail : csb@csb-battery.com

SHANGHAI OFFICE. (CHINA)
CSB BATTERY LOGISTIC (SHANGHAI) CO., LTD.
 Tel : +86-21-5046-1622/5046-0833
 Fax : +86-21-5064-1046
 mail : chinasl@csb-battery.com

EUROPE HQ
CSB Battery Europe BV.
 Tel : +31(0)-180-418-140
 Fax : +31(0)-180-418-327
 mail : eurosales@csb-battery.eu

SHENZHEN OFFICE. (CHINA)
CSB BATTERY LOGISTIC (SHANGHAI) CO., LTD.
 Tel : +86-755-8831-6488/6396/6356
 Fax : +86-755-8831-6548
 mail : she@csb-battery.com.cn