

Powered by



GP 672 ▶ 6V 7.2Ah

GP 672 is a general purpose battery up to 5 years in standby service or more than 260 cycles at 100% discharge in cycle service. As with all CSB batteries, all are rechargeable, highly efficient, leak proof and maintenance free.



► Specification

Cells Per Unit	3
Voltage Per Unit	6
Capacity	7.2Ah @ 20hr-rate to 1.75V per cell @25°C (77°F)
Weight	Approx. 1.22 kg(2.69 lbs)
Maximum Discharge Current	100A/130A(5sec)
Internal Resistance	Approx. 15.5 mΩ
Operating Temperature Range	Discharge: -15°C~50°C (5°F~122°F). Charge: -15°C~40°C (5°F~104°F). Storage: -15°C~40°C (5°F~104°F).
Nominal Operating Temperature Range	25°C±3°C (77°F±5°F).
Float Charging Voltage	6.75 to 6.9 VDC/unit Average at 25°C (77°F)
Recommended Maximum Charging Current Limit	2.16A
Equalization and Cycle Service	7.2 to 7.5 VDC/unit Average at 25°C (77°F)
Self Discharge	CSB Batteries can be stored for more than 6 months at 25°C (77°F). Please charge batteries before using. For higher temperatures the time interval will be shorter.
Terminal	F1/F2-Faston Tab187/250
Container Material	ABS(UL 94-HB) & Flammability resistance of (UL 94-V0) can be available upon request.



CSB-manufactured VRLA batteries are UL-recognized components under UL1989.

CSB is also certified by ISO 9001 and ISO 14001.

► Dimensions :

Unit: mm (inch)

Overall Height (H)	Container height (h)	Length (L)	Width (W)
100±1 (3.94±0.04)	94±1 (3.7±0.04)	151±2 (5.94±0.08)	34±1 (1.34±0.04)

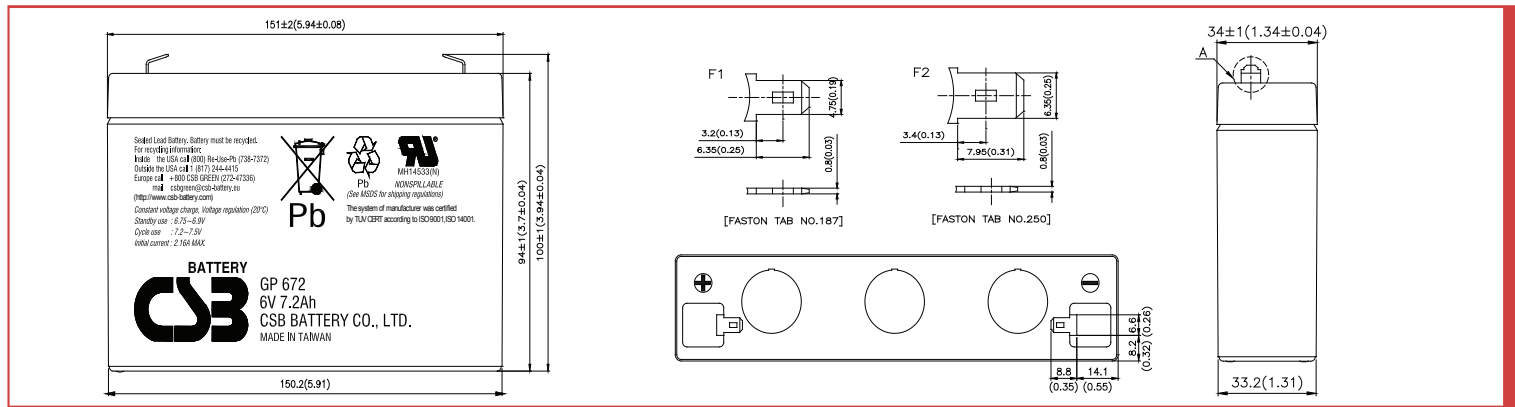

Constant Current Discharge Characteristics Unit:A (25°C,77°F)

F.V/Time	5MIN	10MIN	15MIN	30MIN	60MIN	90MIN	2HR	3HR	5HR	8HR	10HR	20HR
1.60V	35.6	22.0	16.5	9.61	5.51	3.92	3.08	2.13	1.34	0.92	0.77	0.45
1.67V	33.1	21.0	15.9	9.36	5.41	3.85	3.02	2.08	1.31	0.90	0.76	0.44
1.70V	31.9	20.5	15.6	9.24	5.37	3.82	3.00	2.06	1.30	0.89	0.75	0.43
1.75V	29.6	19.6	15.1	9.03	5.30	3.77	2.96	2.02	1.27	0.88	0.74	0.42
1.80V	27.2	18.6	14.4	8.77	5.23	3.71	2.91	1.98	1.25	0.87	0.73	0.42
1.85V	24.5	17.4	13.7	8.44	5.14	3.66	2.87	1.95	1.22	0.86	0.71	0.40

Constant Power Discharge Characteristics Unit:W (25°C,77°F)

F.V/Time	5MIN	10MIN	15MIN	30MIN	60MIN	90MIN	2HR	3HR	5HR	8HR	10HR	20HR
1.60V	180	123	91.4	53.9	32.2	23.5	18.8	13.3	8.62	5.87	4.90	2.68
1.67V	170	118	88.7	52.9	31.8	23.2	18.5	13.2	8.50	5.80	4.84	2.63
1.70V	165	115	87.2	52.4	31.6	23.1	18.4	13.1	8.45	5.76	4.77	2.61
1.75V	157	111	85.0	51.6	31.2	22.8	18.2	13.0	8.36	5.70	4.73	2.57
1.80V	147	106	82.3	50.6	30.9	22.5	18.0	12.8	8.27	5.65	4.70	2.53
1.85V	138	101	79.2	49.5	30.4	22.1	17.7	12.6	8.16	5.60	4.64	2.49

Ratings presented herein are subject to revision without notice. Please refer to www.csb-battery.com to confirm the latest version.

Trickle (or Float) Service Life

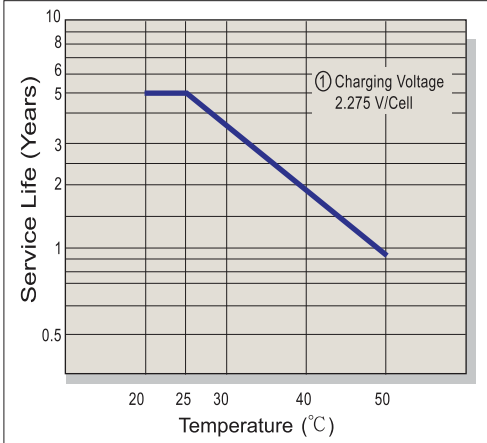

Capacity Retention Characteristic

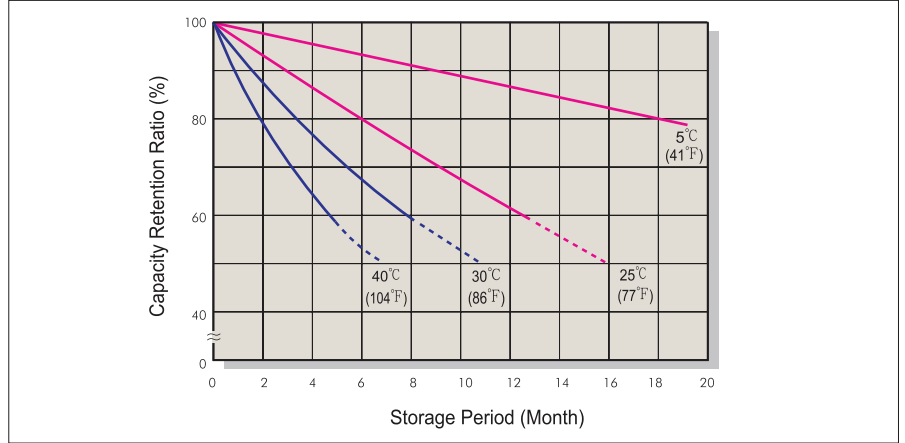

Battery Voltage and Charge Time for Standby Use

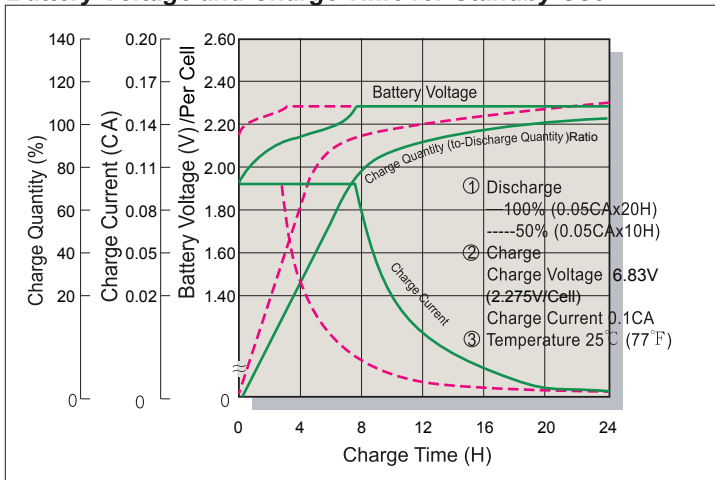

Cycle Service Life

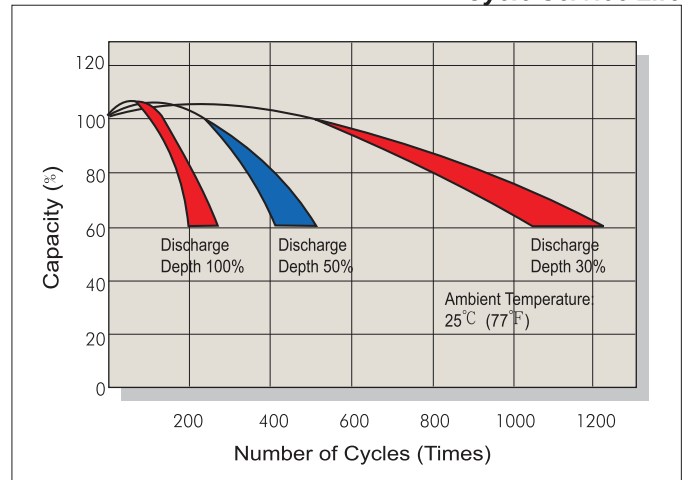

Battery Voltage and Charge Time for Cycle Use

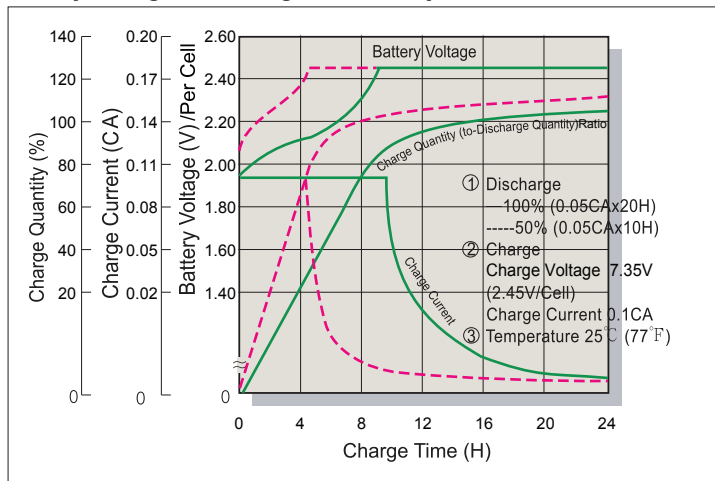

Terminal Voltage (V) and Discharge Time

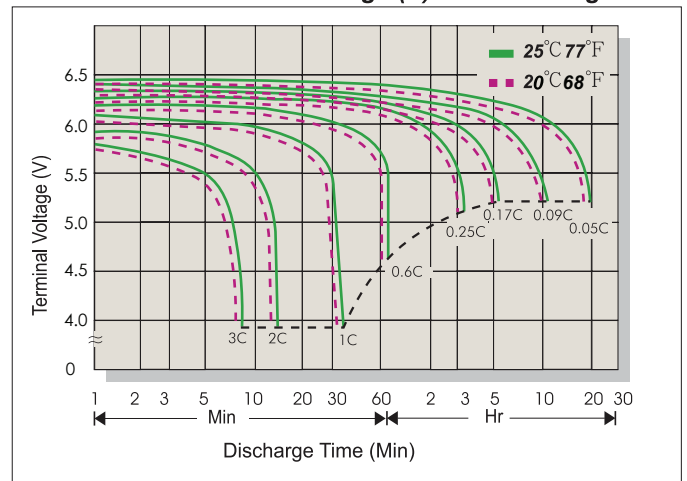

Charging Procedures

Application	Charge Voltage(V/Cell)			Max.Charge Current
	Temperature	Set Point	Allowable Range	
Cycle Use	25°C (77°F)	2.45	2.40~2.50	0.3C
Standby	25°C (77°F)	2.275	2.25~2.30	

Discharge Current VS. Discharge Voltage

Final Discharge Voltage V/Cell	1.75	1.70	1.60	1.30
Discharge Current(A)	0.2C>(A)	0.2C<(A)<0.5C	0.5C<(A)<1.0C	(A)>1.0C

Sales Office URL: WWW.CSB-BATTERY.COM

GLOBAL HQ
CSB BATTERY CO., LTD. (TAIWAN)
 Tel : +886-2-2880-5600
 Fax : +886-2-2888-3300
 mail : service@csb-battery.com.tw

BEIJING OFFICE. (CHINA)
CSB BATTERY TECHNOLOGIES (BEIJING) CO., LTD.
 Tel : +86-10-5820-5336/5338
 Fax : +86-10-58203053
 mail : chinasl@csb-battery.com

AMERICA HQ
CSB BATTERY TECHNOLOGIES INC. (U.S.A)
 Tel : +1-817-244-7777/1-(800)3-CSB-USA(272872)
 Fax : +1-817-244-4445
 mail : csb@csb-battery.com

SHANGHAI OFFICE. (CHINA)
CSB BATTERY LOGISTIC (SHANGHAI) CO., LTD.
 Tel : +86-21-5046-1622/5046-0833
 Fax : +86-21-5064-1046
 mail : chinasl@csb-battery.com

EUROPE HQ
CSB Battery Europe BV.
 Tel : +31(0)-180-418-140
 Fax : +31(0)-180-418-327
 mail : eurosales@csb-battery.eu

SHENZHEN OFFICE. (CHINA)
CSB BATTERY LOGISTIC (SHANGHAI) CO., LTD.
 Tel : +86-755-8831-6488/6396/6356
 Fax : +86-755-8831-6548
 mail : she@csb-battery.com.cn